

Roller chains with U type attachments

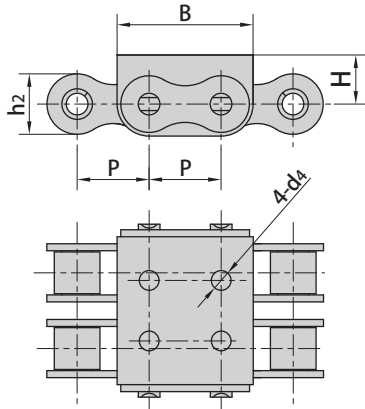

With U1 profile

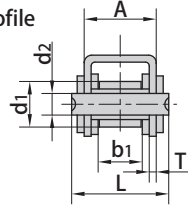

With U2 profile

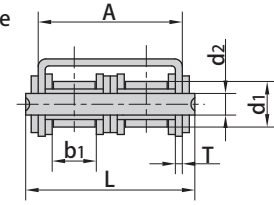

Donghua Chain No.	Pitch	Roller diameter	Width between inner plates	Pin diameter	Pin length	Plate and attachment dimension						Ultimate tensile strength	Weight per meter
	P mm	d1 max mm	b1 min mm	d2 max mm	L max mm	h2 max mm	A mm	B mm	H mm	d4 mm	T mm	Q min kN/lbf	q kg/m
08B-U1	12.700	8.51	7.75	4.45	20.0	11.8	14.60	24.2	8.3	-	1.60	18.0/4091	1.13
08B-U2	12.700	8.51	7.75	4.45	34.3	11.8	28.40	24.2	8.3	-	1.50	32.0/7273	1.96
08B-U2F9	12.700	8.51	7.75	4.45	47.9	11.8	28.40	25.5	8.3	4.0	1.50	29.0/6519	2.00
10B-U1	15.875	10.16	9.65	5.08	23.2	14.7	16.80	30.0	11.3	5.0	1.60	19.0/4318	1.53
10B-U2	15.875	10.16	9.65	5.08	39.7	14.7	33.30	30.0	11.3	5.0	1.50	44.5/10004	2.47
10B-U1F7	15.875	10.16	9.65	5.08	23.2	14.7	16.80	30.0	10.3	-	1.60	22.2/4990	1.53
10B-U1F8	15.875	10.16	9.65	5.08	23.2	14.7	16.80	30.0	11.3	-	1.60	19.0/4318	1.52
10B-U2F2	15.875	10.16	9.65	5.08	39.7	14.7	33.30	30.0	11.3	-	1.50	44.5/10004	2.40
12B-U1	19.050	12.07	11.68	5.72	25.7	16.0	19.60	36.0	13.0	5.0	1.85	29.0/6519	1.90
12B-U2	19.050	12.07	11.68	5.72	45.3	16.0	39.10	36.0	12.0	5.0	1.85	57.8/13136	3.03
16A-U1	25.400	15.88	15.75	7.92	37.2	24.0	27.50	46.0	16.0	-	2.42	56.7/12746	3.87
16B-U1	25.400	15.88	17.02	8.28	39.7	21.0	29.05	49.0	15.4	6.0	1.60	58.0/13407	3.73
16B-U2	25.400	15.88	17.02	8.28	71.7	21.0	60.93	49.0	16.2	-	1.60	106.0/26094	6.15
16B-U2F4	25.400	15.88	17.02	8.28	71.7	21.0	60.93	49.0	16.2	8.4	1.60	106.0/26094	6.64
20BF2	31.750	19.05	19.56	10.19	48.0	26.4	36.00	57.0	21.0	8.0	3.50	85.0/19318	6.01
20B-U1	31.750	19.05	19.56	10.19	48.0	26.4	36.00	57.0	21.0	-	3.50	85.0/19318	6.00
24B-U1	38.100	25.40	25.40	14.63	61.6	33.2	47.00	72.6	28.0	10.0	4.50	160.0/35969	10.88
24B-U1F4	38.100	25.40	25.40	14.63	61.6	33.2	47.00	72.6	28.0	-	4.50	160.0/35969	11.40

Note: the number and position of d4 hole is as per drawing.

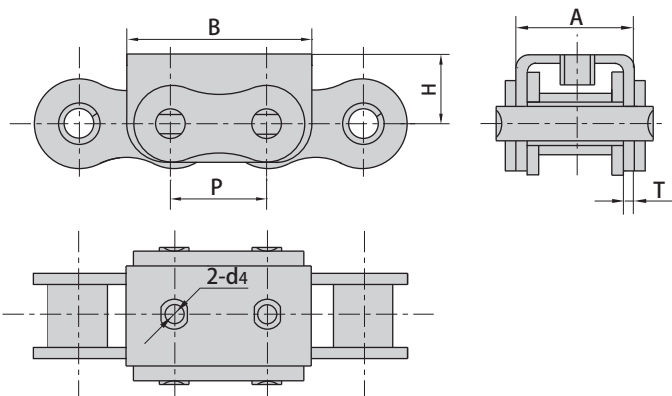

Donghua Chain No.	P mm	A mm	B mm	d4 mm	H mm	T mm
08B-U1F1(a)	12.700	14.6	24.2	M4	9.50	1.60
10B-U1F1(a)	15.875	16.8	30.0	M5	11.30	1.60
12B-U1F10	19.050	19.6	36.0	M5	13.00	1.85
16A-U1F7	25.400	27.3	49.5	M6	16.45	2.30
16B-U1F3	25.400	30.3	49.5	M6	16.45	2.30
16B-U1F4	25.400	29.8	47.8	M5	15.00	2.00
20B-U1F3	31.750	36.0	57.0	M6	21.00	3.50
24B-U1F5	38.100	47.0	72.6	M6	28.00	4.50

Roller chains with U type attachments

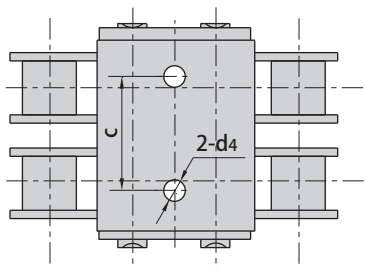
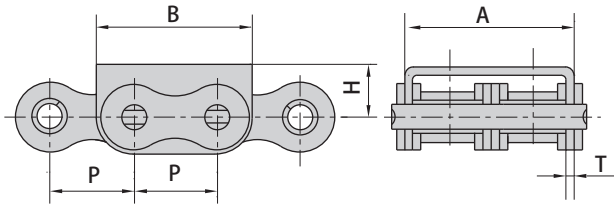

Donghua Chain No.	P	A	B	C	d4	H	T
	mm	mm	mm	mm	mm	mm	mm
08B-U2F2	12.700	28.4	24.2	17.5	3.3	8.3	1.50
10A-U2F1	15.875	36.5	29.0	17.5	3.3	12.0	2.03
12B-U2F7	19.050	38.9	36.0	17.5	3.3	13.2	1.85

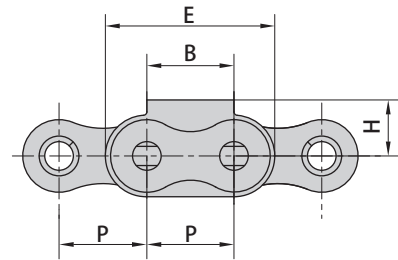
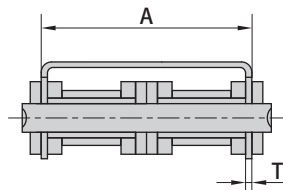

Donghua Chain No.	P	A	B	C	d4	E	H	T
	mm	mm	mm	mm	mm	mm	mm	mm
16B-U2F1	25.4	60.93	25.0	33.5	9.0	49.0	16.2	1.6
16B-U2F5	25.4	64.10	25.0	-	-	46.40	17.0	3.1

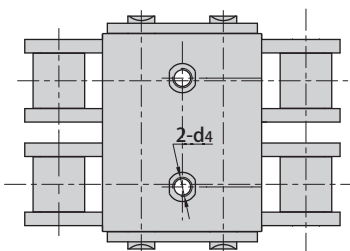
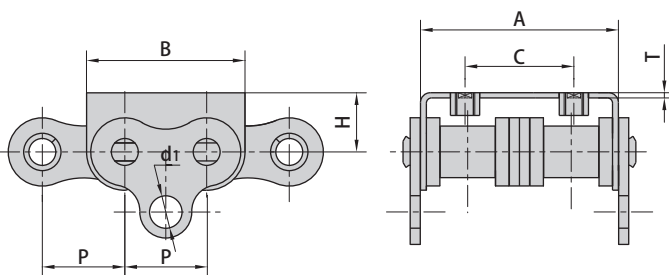
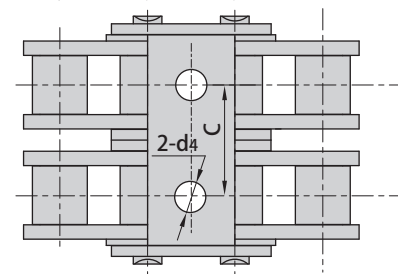

Donghua Chain No.	P	A	B	d4	H	T	C	d1
	mm	mm	mm	mm	mm	mm	mm	mm
16B-U2F2	25.4	60.93	49	M6	18.2	1.6	33.5	10
16B-U2F3	25.4	60.93	49	M6	16.2	1.6	33.5	10

Roller chains with U type attachments

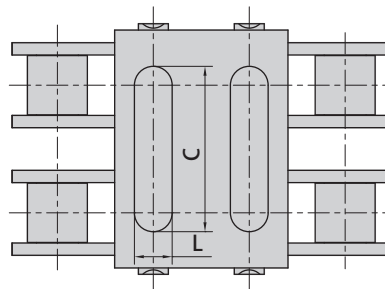
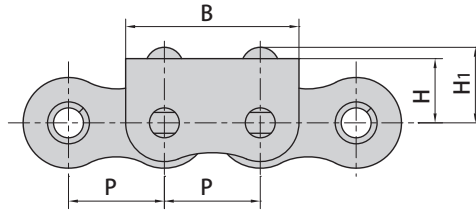

Donghua Chain No.	P	B	H	H1	C	L
	mm	mm	mm	mm	mm	mm
16A-U2F8	25.4	45.9	17.0	20.0	41.0	10.0

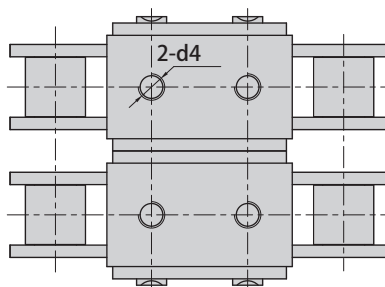
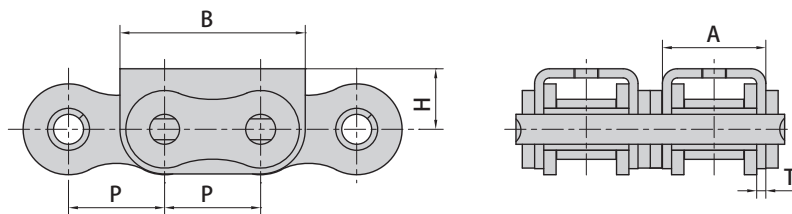

Donghua Chain No.	P	A	B	d4	H	T
	mm	mm	mm	mm	mm	mm
16A-U2F9	25.4	49.0	27.5	M6	16.0	2.42